

## Ersatzteilliste

SEILWINDE

Bauform LSF 200/1-15





## **LIFTKET Hoffmann GmbH**

Dresdener Straße 64-68

04808 Wurzen / Germany

 +49-3425-89 24-0

 +49-3425-89 24-99

 [sales@liftket.de](mailto:sales@liftket.de)

 [www.liftket.de](http://www.liftket.de)

Ho 08/2017 deutsch

## Übersicht

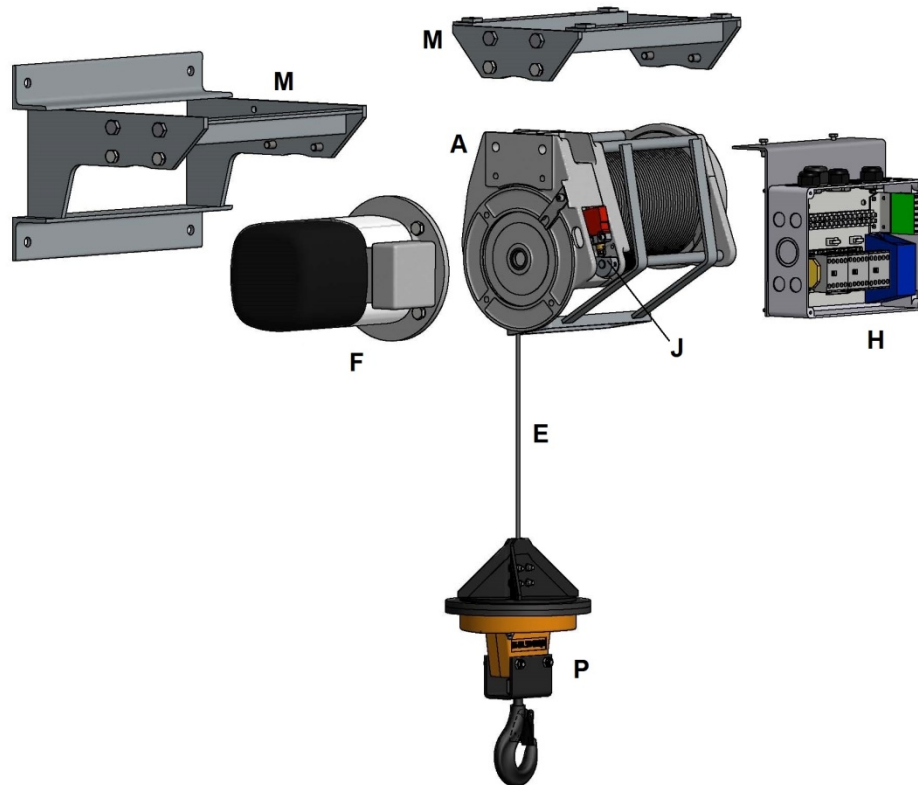

Code	Bezeichnung	Seite
A	Gehäuse	4
E	Seil	5
F	Motor	6
H	Schützsteuerung	7-9
J	Elektrische Endschalter	10
M	Befestigungsmöglichkeiten	11
P	Hakengeschirr	12
	Angebotsformular Ersatzteile	13

## A - Gehäuse

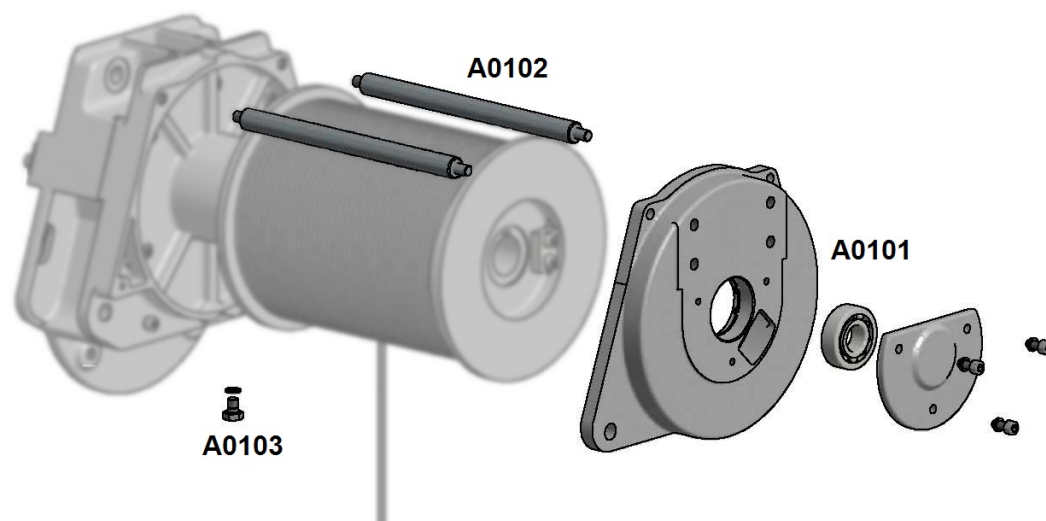

Code	Bezeichnung	Version	Bestellnummer
A0101	Seiltrommellager kpl.		06 9 30L 003/1
A0102	Distanzbolzen		06 0 30L 017/0
A0103	Ölablassschraube kpl.		01 9 00A 201/0

## E - Seil



Code	Bezeichnung	Version		Bestellnummer
<b>E01</b>	Seiltrommel kpl.	66,5 m	aufgelegt	06 2 30L 004/0 066
		81,5 m	aufgelegt	06 2 30L 004/0 081
		86,5 m	aufgelegt	06 2 30L 004/0 086
		91,5 m	aufgelegt	06 2 30L 004/0 091
		101,5 m	aufgelegt	06 2 30L 004/0 101
		121,5 m	aufgelegt	06 2 30L 004/0 121
<b>E0101</b>	Seil Ø 5mm	66,5 m	lose	18 03069 05066
		81,5 m	lose	18 03069 05081
		86,5 m	lose	18 03069 05086
		91,5 m	lose	18 03069 05091
		101,5 m	lose	18 03069 05101
		121,5 m	lose	18 03069 05121

## F - Motor

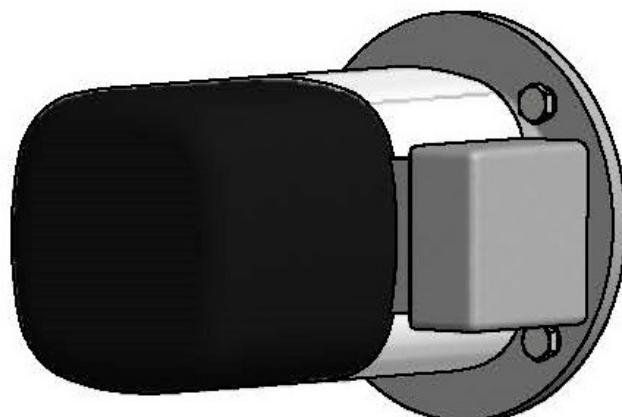

Code	Bezeichnung	Version	Bestellnummer
F01	Motor kpl.		42 2 080KY4 000/0
F0101	Bremse kpl.		17 9 30P 000/1
F0102	Lüfterrad kpl.		55 1B800 00001
F0103	Lüfterhaube kpl.		55 1B800 00002

## H - Schützsteuerung

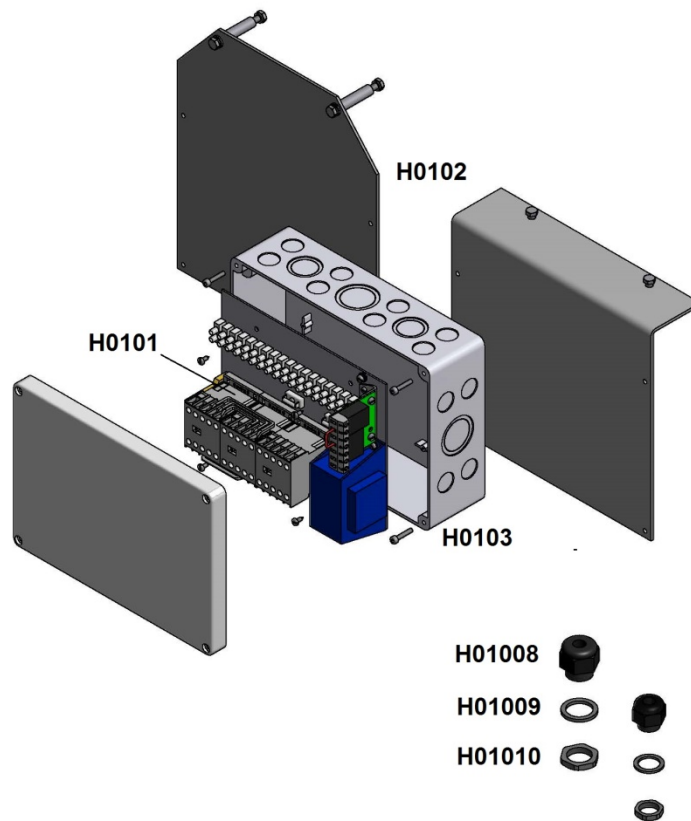

Code	Bezeichnung	Version	Bestellnummer
<b>H0101</b>	Schützsteuerung mit NOT-Halt kpl.		11 2 33L 001/0
<b>H0102</b>	Halteblech kpl.	Winkelbefestigung	11 9 33L 002/2
		Fußbefestigung	11 9 30L 002/1
<b>H0103</b>	Gehäuse Steuerung		20 10000 00021
<b>H01008</b>	Kabelverschraubung	M25 x 1,5/16	50 00400 25160
		M20 x 1,5	50 00100 M2015
<b>H01009</b>	Flachdichtung	M25	50 00300 25001
		M20	50 00300 20001
<b>H01010</b>	Gegenmutter	M25 x 1,5	50 00300 25002G
		M20 x 1,5	50 00300 20002G





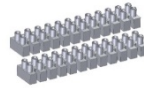
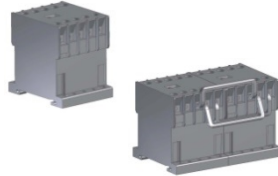
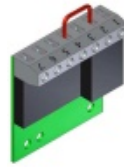

## Komponenten

Code	Bezeichnung	Version	Bestellnummer
H01001	Gleichrichter		20 00040 00040F
H01002	Schütz K1		74 3LC1K 91024
	Schütz K2, K3		74 3LC2K 91024
H01004	Transformator 230-400V/24V		88 00400 EI024
H01005	Set Reihenklemmen		20 00000 00012
H01006	Sicherungshalter		20 00060 00081
H01007	Feinsicherung	1,25 A	20 00060 00082



























## Hängetaster komplett

Code	Bezeichnung	Symbol / Funktion	Bestellnummer
H02	Hängetaster	  	81 A0100 000NH
		   	81 A0100 010NH

## Hängetaster / Komponenten

Code	Bezeichnung	Symbol / Funktion	Bestellnummer
H0202	Schalteinsatz	  	81 ZB2BE 00101
		  	81 ZB2BE 00101
		  NO	81 ZB2BE 00101
		  NC	81 ZB2BE 00102
			81 ZB2BE 00102
H0203	NOT-Halt-Knopf		81 ZA2BS 00834
H0204	Gummitteile für Befehlsstellen 1-stufige Funktion	 	weiß 81 XAC0A 09411
		 	schwarz 81 XAC0A 09412

## Hängetaster / Steuerkabel

Code	Bezeichnung	Symbol / Funktion	Bestellnummer
H0201	Steuerkabel	  	7G1,5 45 0YMH0 07G15
		   	7G1,5 45 0YMH0 07G15

## J – Elektrische Endschalter

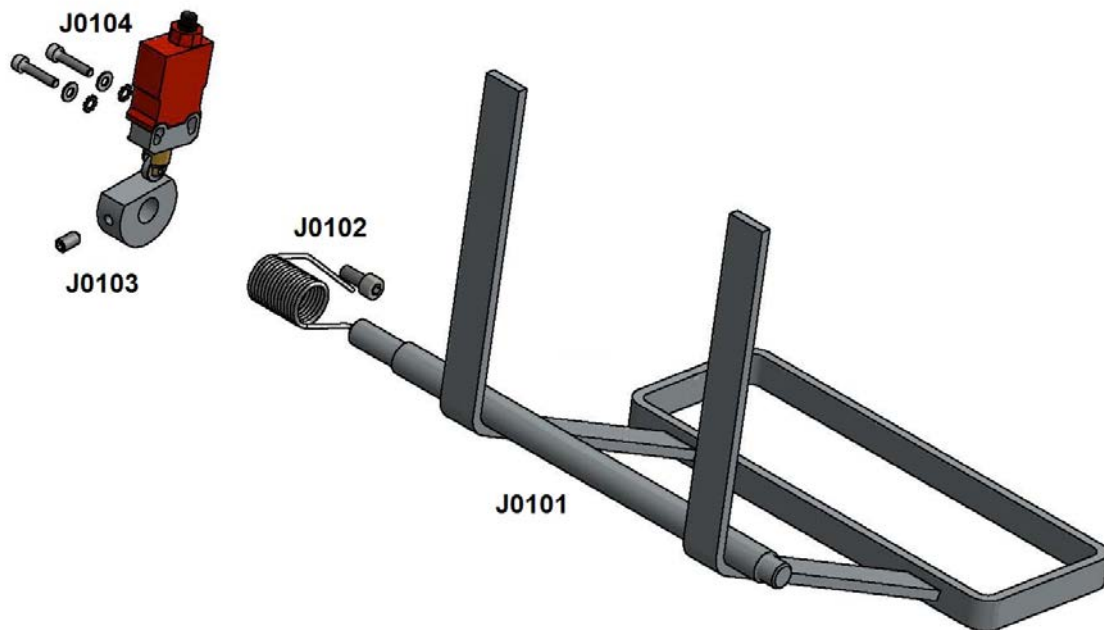

Code	Bezeichnung	Version	Bestellnummer
J01	Baugruppe elektr. Endschalter kpl.		46 9 30P 000/0
J0101	Schalthebel kpl.		06 2 30L 026/0
J0102	Drehfeder kpl.		46 9 30P 032/0
J0103	Endschalternocken kpl.		46 9 30P 031/0
J0104	elektr. Endschalter kpl.		46 9 30P 083/0

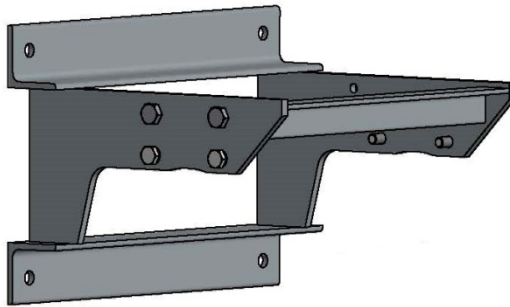
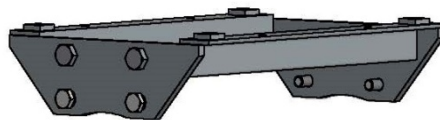
**M - Befestigung****M01****M02**

<b>Code</b>	<b>Bezeichnung</b>	<b>Version</b>	<b>Bestellnummer</b>
<b>M01</b>	Winkelbefestigung kpl.		06 9 31L 000/1
<b>M02</b>	Fußbefestigung kpl.		06 9 30L 097/0

## P - Hakengeschrir



P01



P0105

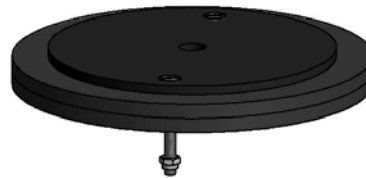

P0104



P0101



P0102

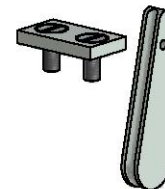

P0103

Code	Bezeichnung	Version	Bestellnummer
P01	Hakengeschrir kpl.	ohne Pendelpuffer	16 2 30H 000/0
		mit Pendelpuffer	16 2 30P 000/0
P0101	Hakengeschrirunterteil kpl.		16 9 30D 002/0
P0102	Hakensicherung kpl.		20 9 020 50 003/0
P0103	Seilbefestigung kpl.		16 9 30D 009/0
P0104	Pendelpuffer kpl.		16 2 31P 000/0
P0105	Abweiser kpl.		16 2 31P 010/1

## Angebotsformular Ersatzteile

Kunden-Nr. \_\_\_\_\_  
Anschritt: \_\_\_\_\_  
\_\_\_\_\_  
\_\_\_\_\_  
\_\_\_\_\_  
\_\_\_\_\_  
\_\_\_\_\_  
\_\_\_\_\_



**LIFTKET Hoffmann GmbH**  
Dresdener Straße 64-68  
04808 Wurzen / Deutschland

+49-3425-89 24-0  
 +49-3425-89 24-99  
 sales@liftket.de  
 www.liftket.com

**Elektrokettenzug** Typ: \_\_\_\_\_ Spannung: \_\_\_\_\_ V \_\_\_\_\_ Hz \_\_\_\_\_ ph  
Fabrik-Nr.: \_\_\_\_\_ Steuerung: \_\_\_\_\_ V

Code	Bezeichnung	Version	Bestell-Nr.	Stück / Meter

\_\_\_\_\_  
Ort / Datum

\_\_\_\_\_  
Unterschrift

\_\_\_\_\_  
Stempel

